

NTA JEE Mains Jan 2026

Application No	260310367978
Candidate Name	NAVYA BEDI
Roll No.	DL010306565
Test Date	24/01/2026
Test Time	3:00 PM - 6:00 PM
Subject	B. Tech

Section : Mathematics Section A

Q.1 The smallest positive integral value of a , for which all the roots of $x^4 - ax^2 + 9 = 0$ are real and distinct, is equal to

- Options
- 9
 - 4
 - 7
 - 3

Question Type : MCQ
Question ID : 444792603
Option 1 ID : 4447922052
Option 2 ID : 4447922051
Option 3 ID : 4447922050
Option 4 ID : 4447922049
Status : Marked For Review
Chosen Option : 3

Q.2 The largest value of n , for which 40^n divides $60!$, is

- Options
- 14
 - 13
 - 11
 - 12

Question Type : MCQ
Question ID : 444792607
Option 1 ID : 4447922067
Option 2 ID : 4447922066
Option 3 ID : 4447922068
Option 4 ID : 4447922065
Status : Marked For Review
Chosen Option : 1

Q.3 Let $P = [p_{ij}]$ and $Q = [q_{ij}]$ be two square matrices of order 3 such that $q_{ij} = 2^{(i+j-1)} p_{ij}$ and $\det(Q) = 2^{10}$. Then the value of $\det(\text{adj}(\text{adj } P))$ is:

- Options
1. 16
 2. 124
 3. 32
 4. 81

Question Type : MCQ
Question ID : 444792604
Option 1 ID : 4447922053
Option 2 ID : 4447922056
Option 3 ID : 4447922055
Option 4 ID : 4447922054
Status : Answered
Chosen Option : 1

Q.4 Let a_1, a_2, a_3, a_4 be an A.P. of four terms such that each term of the A.P. and its common difference l are integers. If $a_1 + a_2 + a_3 + a_4 = 48$ and $a_1 a_2 a_3 a_4 + l^4 = 361$, then the largest term of the A.P. is equal to

- Options
1. 21
 2. 27
 3. 23
 4. 24

Question Type : MCQ
Question ID : 444792605
Option 1 ID : 4447922057
Option 2 ID : 4447922060
Option 3 ID : 4447922058
Option 4 ID : 4447922059
Status : Not Attempted and Marked For Review
Chosen Option : --

Q.5 Let f be a function such that $3f(x) + 2f\left(\frac{m}{19x}\right) = 5x$, $x \neq 0$, where

$$m = \sum_{i=1}^9 (i)^2. \text{ Then } f(5) - f(2) \text{ is equal to}$$

- Options
1. - 9
 2. 9
 3. 36
 4. 18

Question Type : MCQ
Question ID : 444792602
Option 1 ID : 4447922045
Option 2 ID : 4447922046
Option 3 ID : 4447922048
Option 4 ID : 4447922047
Status : Answered
Chosen Option : 4

Q.6 Let $\vec{a} = 2\hat{i} - 5\hat{j} + 5\hat{k}$ and $\vec{b} = \hat{i} - \hat{j} + 3\hat{k}$. If \vec{c} is a vector such that $2(\vec{a} \times \vec{c}) + 3(\vec{b} \times \vec{c}) = \vec{0}$ and $(\vec{a} - \vec{b}) \cdot \vec{c} = -97$, then $|\vec{c} \times \hat{k}|^2$ is equal to

- Options
1. 205
 2. 218
 3. 233
 4. 193

Question Type : MCQ
 Question ID : 444792615
 Option 1 ID : 4447922098
 Option 2 ID : 4447922099
 Option 3 ID : 4447922100
 Option 4 ID : 4447922097
 Status : Not Answered
 Chosen Option : --

Q.7 If the domain of the function $f(x) = \sin^{-1}\left(\frac{1}{x^2 - 2x - 2}\right)$ is $(-\infty, \alpha] \cup [\beta, \gamma] \cup [\delta, \infty)$, then $\alpha + \beta + \gamma + \delta$ is equal to

- Options
1. 5
 2. 4
 3. 3
 4. 2

Question Type : MCQ
 Question ID : 444792601
 Option 1 ID : 4447922044
 Option 2 ID : 4447922043
 Option 3 ID : 4447922042
 Option 4 ID : 4447922041
 Status : Not Answered
 Chosen Option : --

Q.8 Let the length of the latus rectum of an ellipse $\frac{x^2}{a^2} + \frac{y^2}{b^2} = 1$, ($a > b$), be 30. If its eccentricity is the maximum value of the function $f(t) = -\frac{3}{4} + 2t - t^2$, then $(a^2 + b^2)$ is equal to

- Options
1. 496
 2. 256
 3. 516
 4. 276

Question Type : MCQ
 Question ID : 444792610
 Option 1 ID : 4447922078
 Option 2 ID : 4447922077
 Option 3 ID : 4447922079
 Option 4 ID : 4447922080
 Status : Answered
 Chosen Option : 1

Q.9

Let $f(x) = \int \frac{7x^{10} + 9x^8}{(1+x^2 + 2x^9)^2} dx, x > 0, \lim_{x \rightarrow 0} f(x) = 0$ and $f(1) = \frac{1}{4}$.

If $A = \begin{bmatrix} 0 & 0 & 1 \\ \frac{1}{4} & f'(1) & 1 \\ \alpha^2 & 4 & 1 \end{bmatrix}$ and $B = \text{adj}(\text{adj } A)$ be such that $|B| = 81$, then α^2 is

equal to

- Options
1. 2
 2. 1
 3. 3
 4. 4

Question Type : MCQ

Question ID : 444792618

Option 1 ID : 4447922110

Option 2 ID : 4447922109

Option 3 ID : 4447922111

Option 4 ID : 4447922112

Status : Answered

Chosen Option : 4

Q.10 Let the image of parabola $x^2 = 4y$, in the line $x - y = 1$ be $(y + a)^2 = b(x - c)$, $a, b, c \in \mathbb{N}$. Then $a + b + c$ is equal to

- Options
1. 12
 2. 8
 3. 6
 4. 4

Question Type : MCQ

Question ID : 444792611

Option 1 ID : 4447922084

Option 2 ID : 4447922083

Option 3 ID : 4447922082

Option 4 ID : 4447922081

Status : Not Answered

Chosen Option : --

Q.11 The sum of all values of α , for which the shortest distance between the lines

$$\frac{x+1}{\alpha} = \frac{y-2}{-1} = \frac{z-4}{-\alpha} \text{ and } \frac{x}{\alpha} = \frac{y-1}{2} = \frac{z-1}{2\alpha} \text{ is } \sqrt{2}, \text{ is}$$

- Options
1. 6
 2. 8
 3. - 8
 4. - 6

Question Type : MCQ

Question ID : 444792613

Option 1 ID : 4447922090

Option 2 ID : 4447922092

Option 3 ID : 4447922091

Option 4 ID : 4447922089

Status : Answered

Chosen Option : 4

Q.12 Let $\vec{a} = 2\hat{i} - \hat{j} - \hat{k}$, $\vec{b} = \hat{i} + 3\hat{j} - \hat{k}$ and $\vec{c} = 2\hat{i} + \hat{j} + 3\hat{k}$. Let \vec{v} be the vector in the plane of the vectors \vec{a} and \vec{b} , such that the length of its projection on the vector \vec{c} is $\frac{1}{\sqrt{14}}$. Then $|\vec{v}|$ is equal to

- Options
1. 7
 2. $\frac{\sqrt{35}}{2}$
 3. 13
 4. $\frac{\sqrt{21}}{2}$

Question Type : MCQ

Question ID : 444792614

Option 1 ID : 4447922093

Option 2 ID : 4447922096

Option 3 ID : 4447922094

Option 4 ID : 4447922095

Status : Not Attempted and Marked For Review

Chosen Option : --

Q.13 Let $f(a)$ denote the area of the region in the first quadrant bounded by $x = 0$, $x = 1$, $y^2 = x$ and $y = |ax - 5| - |1 - ax| + ax^2$. Then $(f(0) + f(1))$ is equal to

- Options
1. 7
 2. 14
 3. 9
 4. 12

Question Type : MCQ

Question ID : 444792619

Option 1 ID : 4447922113

Option 2 ID : 4447922116

Option 3 ID : 4447922114

Option 4 ID : 4447922115

Status : Not Answered

Chosen Option : --

Q.14 Consider the following three statements for the function $f: (0, \infty) \rightarrow \mathbb{R}$ defined by $f(x) = |\log_e x| - |x - 1|$:

(I) f is differentiable at all $x > 0$.
 (II) f is increasing in $(0, 1)$.
 (III) f is decreasing in $(1, \infty)$.
 Then.

- Options
1. Only (I) and (III) are TRUE.
 2. Only (II) and (III) are TRUE.
 3. Only (I) is TRUE.
 4. All (I), (II) and (III) are TRUE.

Question Type : MCQ

Question ID : 444792617

Option 1 ID : 4447922107

Option 2 ID : 4447922106

Option 3 ID : 4447922105

Option 4 ID : 4447922108

Status : Not Attempted and Marked For Review

Chosen Option : --

Q.15 $\left(\frac{1}{3} + \frac{4}{7}\right) + \left(\frac{1}{3^2} + \frac{1}{3} \times \frac{4}{7} + \frac{4^2}{7^2}\right) + \left(\frac{1}{3^3} + \frac{1}{3^2} \times \frac{4}{7} + \frac{1}{3} \times \frac{4^2}{7^2} + \frac{4^3}{7^3}\right) + \dots$ upto infinite terms,

is equal to

- Options
1. $\frac{4}{3}$
 2. $\frac{5}{2}$
 3. $\frac{7}{4}$
 4. $\frac{6}{5}$

Question Type : MCQ

Question ID : 444792606

Option 1 ID : 4447922062

Option 2 ID : 4447922063

Option 3 ID : 4447922064

Option 4 ID : 4447922061

Status : Not Answered

Chosen Option : --

Q.16 Let $X = \{x \in \mathbb{N} : 1 \leq x \leq 19\}$ and for some $a, b \in \mathbb{R}$, $Y = \{ax + b : x \in X\}$.
If the mean and variance of the elements of Y are 30 and 750, respectively, then
the sum of all possible values of b is

- Options
1. 60
 2. 100
 3. 80
 4. 20

Question Type : MCQ

Question ID : 444792609

Option 1 ID : 4447922074

Option 2 ID : 4447922076

Option 3 ID : 4447922075

Option 4 ID : 4447922073

Status : Not Attempted and
Marked For Review

Chosen Option : --

Q.17 Let the angles made with the positive x -axis by two straight lines drawn from the point $P(2, 3)$ and meeting the line $x + y = 6$ at a distance $\sqrt{\frac{2}{3}}$ from the point P be θ_1 and θ_2 . Then the value of $(\theta_1 + \theta_2)$ is:

- Options
1. $\frac{\pi}{6}$
 2. $\frac{\pi}{12}$
 3. $\frac{\pi}{3}$
 4. $\frac{\pi}{2}$

Question Type : **MCQ**
 Question ID : **444792612**
 Option 1 ID : **4447922087**
 Option 2 ID : **4447922088**
 Option 3 ID : **4447922085**
 Option 4 ID : **4447922086**
 Status : **Not Answered**
 Chosen Option : --

Q.18 Let $y = y(x)$ be a differentiable function in the interval $(0, \infty)$ such that $y(1) = 2$,

and $\lim_{t \rightarrow x} \left(\frac{t^2 y(x) - x^2 y(t)}{x - t} \right) = 3$ for each $x > 0$. Then $2y(2)$ is equal to

- Options
1. 23
 2. 12
 3. 27
 4. 18

Question Type : **MCQ**
 Question ID : **444792620**
 Option 1 ID : **4447922117**
 Option 2 ID : **4447922118**
 Option 3 ID : **4447922120**
 Option 4 ID : **4447922119**
 Status : **Not Answered**
 Chosen Option : --

Q.19 The letters of the word "UDAYPUR" are written in all possible ways with or without meaning and these words are arranged as in a dictionary. The rank of the word "UDAYPUR" is

- Options
1. 1578
 2. 1581
 3. 1580
 4. 1579

Question Type : **MCQ**
 Question ID : **444792608**
 Option 1 ID : **4447922069**
 Option 2 ID : **4447922072**
 Option 3 ID : **4447922071**
 Option 4 ID : **4447922070**
 Status : **Answered**
 Chosen Option : **3**

Q.20 Let $[t]$ denote the greatest integer less than or equal to t . If the function

$$f(x) = \begin{cases} b^2 \sin\left(\frac{\pi}{2}\left[\frac{\pi}{2}(\cos x + \sin x)\cos x\right]\right), & x < 0 \\ \frac{\sin x - \frac{1}{2}\sin 2x}{x^3}, & x > 0 \\ a, & x = 0 \end{cases}$$

is continuous at $x = 0$, then $a^2 + b^2$ is equal to

- Options
1. $\frac{1}{2}$
 2. $\frac{3}{4}$
 3. $\frac{5}{8}$
 4. $\frac{9}{16}$

Question Type : MCQ

Question ID : 444792616

Option 1 ID : 4447922103

Option 2 ID : 4447922101

Option 3 ID : 4447922104

Option 4 ID : 4447922102

Status : Answered

Chosen Option : 2

Section : Mathematics Section B

Q.21 Let $z = (1 + i)(1 + 2i)(1 + 3i) \dots (1 + ni)$, where $i = \sqrt{-1}$. If $|z|^2 = 44200$, then n is equal to ____

Given Answer --
:

Question Type : SA

Question ID : 444792621

Status : Not Answered

Q.22 Let S be a set of 5 elements and $P(S)$ denote the power set of S . Let E be an event of choosing an ordered pair (A, B) from the set $P(S) \times P(S)$ such that $A \cap B = \emptyset$. If the probability of the event E is $\frac{3^p}{2^q}$, where $p, q \in \mathbb{N}$, then $p + q$ is equal to _____

Given Answer --
:

Question Type : SA
Question ID : 444792622
Status : Not Answered

Q.23 The number of elements in the set $\{x \in [0, 180^\circ] : \tan(x + 100^\circ) = \tan(x + 50^\circ) \tan x \tan(x - 50^\circ)\}$ is _____.

Given Answer --
:

Question Type : SA
Question ID : 444792624
Status : Not Answered

Q.24 If $f(x)$ satisfies the relation $f(x) = e^x + \int_0^1 (y + xe^x) f(y) dy$, then $e + f(0)$ is equal to _____.

Given Answer --
:

Question Type : SA
Question ID : 444792625
Status : Not Answered

Q.25 Let (h, k) lie on the circle $C : x^2 + y^2 = 4$ and the point $(2h + 1, 3k + 2)$ lie on an ellipse with eccentricity e . Then the value of $\frac{5}{e^2}$ is equal to _____.

Given Answer --
:

Question Type : SA
Question ID : 444792623
Status : Not Answered

Q.26 In a vernier callipers, 50 vernier scale divisions are equal to 48 main scale divisions. If one main scale division = 0.05 mm, then the least count of the vernier callipers is _____ mm.

- Options**
1. 0.05
 2. 0.02
 3. 0.005
 4. 0.002

Question Type : **MCQ**
Question ID : **444792626**
Option 1 ID : **4447922128**
Option 2 ID : **4447922126**
Option 3 ID : **4447922129**
Option 4 ID : **4447922127**
Status : **Answered**
Chosen Option : **4**

Q.27 A cubical block of density $\rho_b = 600 \text{ kg/m}^3$ floats in a liquid of density $\rho_e = 900 \text{ kg/m}^3$. If the height of block is $H = 8.0 \text{ cm}$ then height of the submerged part is _____ cm.

- Options**
1. 4.3
 2. 6.3
 3. 5.3
 4. 7.3

Question Type : **MCQ**
Question ID : **444792631**
Option 1 ID : **4447922146**
Option 2 ID : **4447922148**
Option 3 ID : **4447922147**
Option 4 ID : **4447922149**
Status : **Answered**
Chosen Option : **3**

Q.28

A thin uniform rod (X) of mass M and length L is pivoted at a height $\left(\frac{L}{3}\right)$ as shown in the figure. The rod is allowed to fall from a vertical position and lie horizontally on the table. The angular velocity of this rod when it hits the table top, is _____.
(g = gravitational acceleration)

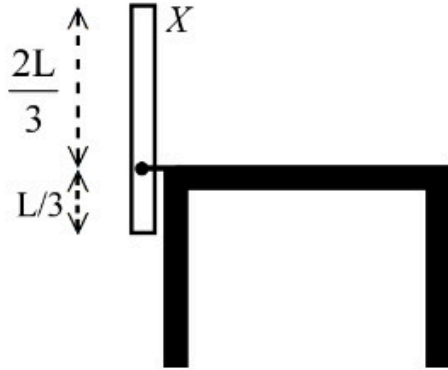

Options

1. $\frac{3}{\sqrt{2}} \sqrt{\frac{g}{L}}$
2. $\sqrt{\frac{3g}{2L}}$
3. $\sqrt{\frac{3g}{L}}$
4. $\frac{1}{\sqrt{2}} \sqrt{\frac{g}{L}}$

Question Type : MCQ

Question ID : 444792627

Option 1 ID : 4447922131

Option 2 ID : 4447922130

Option 3 ID : 4447922132

Option 4 ID : 4447922133

Status : Marked For Review

Chosen Option : 3

Q.29 The reading of the ammeter (A) in steady state in the following circuit (assuming negligible internal resistance of the ammeter) is _____ A.

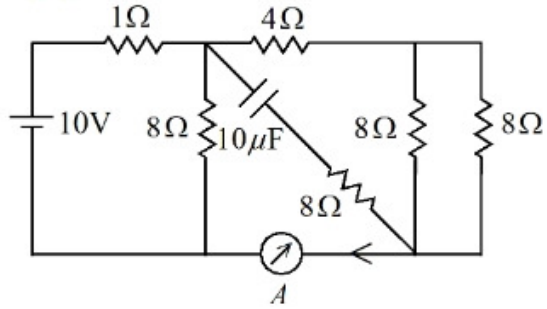

- Options
1. $1/2$
 2. 0
 3. 1
 4. 2

Question Type : MCQ

Question ID : 4447922645

Option 1 ID : 4447922203

Option 2 ID : 4447922205

Option 3 ID : 4447922202

Option 4 ID : 4447922204

Status : Marked For Review

Chosen Option : 3

- Q.30 In case of vertical circular motion of a particle by a thread of length r if the tension in the thread is zero at an angle 30° shown in figure, the velocity at the bottom point (A) of the circular path is (g = gravitational acceleration)

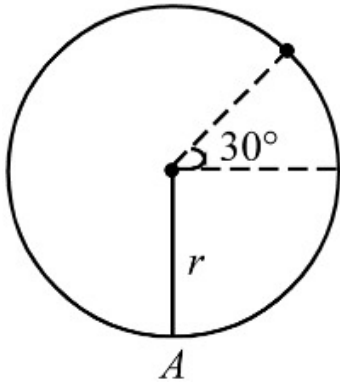

- Options
1. $\sqrt{4gr}$
 2. $\sqrt{\frac{5}{2}gr}$
 3. $\sqrt{5gr}$
 4. $\sqrt{\frac{7}{2}gr}$

Question Type : MCQ

Question ID : 444792630

Option 1 ID : 4447922145

Option 2 ID : 4447922142

Option 3 ID : 4447922143

Option 4 ID : 4447922144

Status : Answered

Chosen Option : 1

Q.31 Identify the correct truth table of the given logic circuit.

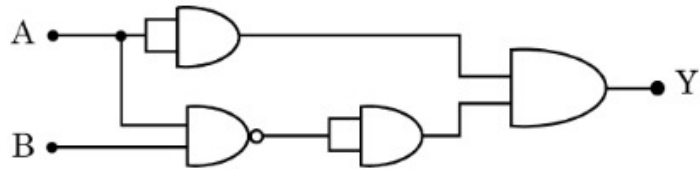

Options

1.

A	B	Y
0	0	0
0	1	0
1	0	1
1	1	0

2.

A	B	Y
0	0	0
0	1	1
1	0	1
1	1	0

3.

A	B	Y
0	0	1
0	1	0
1	0	1
1	1	0

4.

A	B	Y
0	0	1
0	1	1
1	0	1
1	1	0

Question Type : MCQ

Question ID : 444792644

Option 1 ID : 4447922200

Option 2 ID : 4447922198

Option 3 ID : 4447922199

Option 4 ID : 4447922201

Status : Not Answered

Chosen Option : --

Q.32 A flexible chain of mass m hangs between two fixed points at the same level. The inclination of the chain with the horizontal at the two points of support is 30° . Considering the equilibrium of each half of the chain, the tension of the chain at the lowest point is _____.

Options

1. $\frac{\sqrt{3}}{2}mg$
2. $\sqrt{3}mg$
3. mg
4. $\frac{1}{2}mg$

Question Type : MCQ

Question ID : 444792629

Option 1 ID : 4447922138

Option 2 ID : 4447922139

Option 3 ID : 4447922141

Option 4 ID : 4447922140

Status : Not Attempted and
Marked For Review

Chosen Option : --

Q.33 In the Young's double slit experiment the intensity produced by each one of the individual slits is I_0 . The distance between two slits is 2 mm . The distance of screen from slits is 10 m. The wavelength of light is 6000 \AA . The intensity of light on the screen in front of one of the slits is _____.

Options

1. $4I_0$
2. I_0
3. $2I_0$
4. $\frac{I_0}{2}$

Question Type : MCQ

Question ID : 444792640

Option 1 ID : 4447922185

Option 2 ID : 4447922183

Option 3 ID : 4447922184

Option 4 ID : 4447922182

Status : Not Attempted and
Marked For Review

Chosen Option : --

Q.34 When a light of a given wavelength falls on a metallic surface the stopping potential for photoelectrons is 3.2 V. If a second light having wavelength twice of first light is used, the stopping potential drops to 0.7 V. The wavelength of first light is _____ m.

$$(h = 6.63 \times 10^{-34} \text{ J.s, } e = 1.6 \times 10^{-19} \text{ C, } c = 3 \times 10^8 \text{ m/s})$$

- Options**
1. 3.1×10^{-7}
 2. 2.9×10^{-8}
 3. 2.2×10^{-8}
 4. 2.5×10^{-7}

Question Type : **MCQ**
Question ID : **444792642**
Option 1 ID : **4447922190**
Option 2 ID : **4447922192**
Option 3 ID : **4447922193**
Option 4 ID : **4447922191**
Status : **Answered**
Chosen Option : **4**

Q.35 Five persons P_1, P_2, P_3, P_4 and P_5 recorded object distance (u) and image distance (v) using same convex lens having power +5D as (25,96), (30,62), (35,37), (45,35) and (50,32) respectively. Identify correct statement

- Options**
1. Readings recorded by P_4 and P_5 persons are incorrect
 2. Readings recorded by P_3 person are incorrect
 3. Readings recorded by P_3 and P_2 persons are incorrect
 4. Readings recorded by all persons are correct

Question Type : **MCQ**
Question ID : **444792639**
Option 1 ID : **4447922181**
Option 2 ID : **4447922179**
Option 3 ID : **4447922180**
Option 4 ID : **4447922178**
Status : **Not Attempted and Marked For Review**
Chosen Option : **--**

Q.36 The fifth harmonic of a closed organ pipe is found to be in unison with the first harmonic of an open pipe. The ratio of lengths of closed pipe to that of the open pipe is $5/x$. The value of x is _____.

- Options**
1. 3
 2. 2
 3. 4
 4. 1

Question Type : **MCQ**
Question ID : **444792633**
Option 1 ID : **4447922155**
Option 2 ID : **4447922154**
Option 3 ID : **4447922156**
Option 4 ID : **4447922157**
Status : **Marked For Review**
Chosen Option : **2**

Q.37 The binding energy for the following nuclear reactions are expressed in MeV.

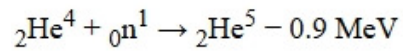
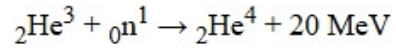

If X_3, X_4, X_5 denote the stability of ${}_2\text{He}^3, {}_2\text{He}^4$ and ${}_2\text{He}^5$, respectively, then the correct order is :

- Options
1. $X_4 > X_5 < X_3$
 2. $X_4 > X_5 > X_3$
 3. $X_4 < X_5 < X_3$
 4. $X_4 = X_5 = X_3$

Question Type : MCQ

Question ID : 444792643

Option 1 ID : 4447922197

Option 2 ID : 4447922195

Option 3 ID : 4447922194

Option 4 ID : 4447922196

Status : Answered

Chosen Option : 2

Q.38 10 mole of an ideal gas is undergoing the process shown in the figure. The heat involved in the process from P_1 to P_2 is α Joule ($P_1 = 21.7$ Pa and $P_2 = 30$ Pa, $C_v = 21$ J/K.mol, $R = 8.3$ J/mol.K). The value of α is _____.

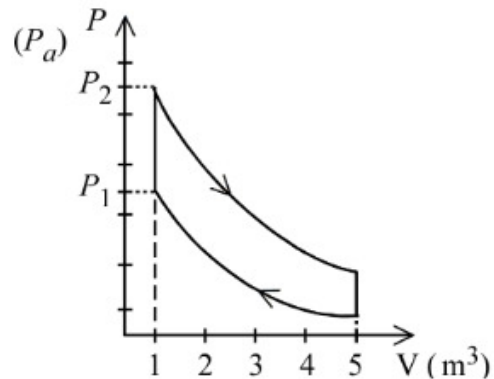

- Options
1. 28
 2. 15
 3. 24
 4. 21

Question Type : MCQ

Question ID : 444792632

Option 1 ID : 4447922153

Option 2 ID : 4447922150

Option 3 ID : 4447922152

Option 4 ID : 4447922151

Status : Not Answered

Chosen Option : --

Q.39 Distance between an object and three times magnified real image is 40 cm. The focal length of the mirror used is _____ cm.

- Options
1. $-15/2$
 2. -20
 3. -15
 4. -10

Question Type : **MCQ**
Question ID : **444792641**
Option 1 ID : **4447922187**
Option 2 ID : **4447922189**
Option 3 ID : **4447922188**
Option 4 ID : **4447922186**
Status : **Answered**
Chosen Option : **3**

Q.40 A moving coil galvanometer of resistance $100\ \Omega$ shows a full scale deflection for a current of 1 mA. The value of resistance required to convert this galvanometer into an ammeter, showing full scale deflection for a current of 5 mA, is _____ Ω

- Options
1. 10
 2. 2.5
 3. 0.5
 4. 25

Question Type : **MCQ**
Question ID : **444792634**
Option 1 ID : **4447922160**
Option 2 ID : **4447922158**
Option 3 ID : **4447922159**
Option 4 ID : **4447922161**
Status : **Answered**
Chosen Option : **4**

Q.41 A regular hexagon is formed by six wires each of resistance $r\ \Omega$ and the corners are joined to the centre by wires of same resistance. If the current enters at one corner and leaves at the opposite corner, the equivalent resistance of the hexagon between the two opposite corners will be

- Options
1. $\frac{3}{4}r$
 2. $\frac{4}{5}r$
 3. $\frac{3}{5}r$
 4. $\frac{5}{8}r$

Question Type : **MCQ**
Question ID : **444792636**
Option 1 ID : **4447922166**
Option 2 ID : **4447922168**
Option 3 ID : **4447922167**
Option 4 ID : **4447922169**
Status : **Not Attempted and Marked For Review**
Chosen Option : **--**

Q.42

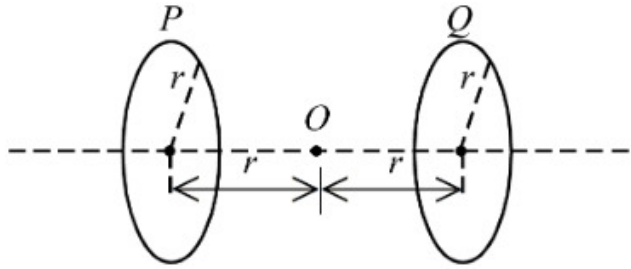

Two identical circular loops P and Q each of radius r are lying in parallel planes such that they have common axis. The current through P and Q are I and $4I$ respectively in clockwise direction as seen from O . The net magnetic field at O is:

- Options
1. $\frac{3\mu_0 I}{4\sqrt{2}r}$ towards Q
 2. $\frac{3\mu_0 I}{4\sqrt{2}r}$ towards P
 3. $\frac{\mu_0 I}{4\sqrt{2}r}$ towards P
 4. $\frac{\mu_0 I}{4\sqrt{2}r}$ towards Q

Question Type : MCQ

Question ID : 444792635

Option 1 ID : 4447922163

Option 2 ID : 4447922162

Option 3 ID : 4447922164

Option 4 ID : 4447922165

Status : Answered

Chosen Option : 2

Q.43 Three parallel plate capacitors each with area A and separation d are filled with two dielectric (k_1 and k_2) in the following fashion. Which of the following is true?
($k_1 > k_2$)

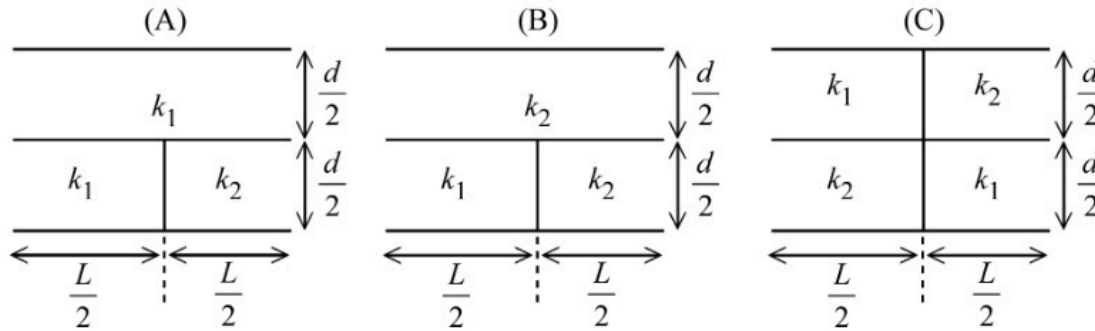

- Options
1. $C_A > C_C > C_B$
 2. $C_C > C_B > C_A$
 3. $C_B > C_C > C_A$
 4. $C_C > C_A > C_B$

Q.44 A point source is kept at the center of a spherically enclosed detector. If the volume of the detector increased by 8 times, the intensity will

- Options
1. increase by 8 times
 2. increase by 64 times
 3. decrease by 8 times
 4. decrease by 4 times

Question Type : MCQ

Question ID : 444792637

Option 1 ID : 4447922170

Option 2 ID : 4447922171

Option 3 ID : 4447922172

Option 4 ID : 4447922173

Status : Marked For Review

Chosen Option : 4

Question Type : MCQ

Question ID : 444792638

Option 1 ID : 4447922174

Option 2 ID : 4447922175

Option 3 ID : 4447922176

Option 4 ID : 4447922177

Status : Marked For Review

Chosen Option : 4

Q.45 The velocity (v) – Distance (x) graph is shown in figure. Which graph represents acceleration(a) versus distance (x) variation of this system?

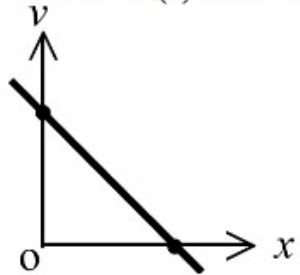

Options

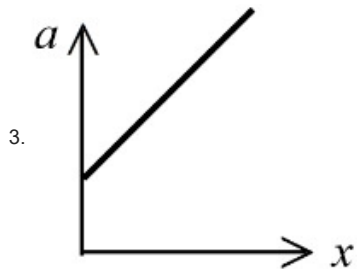
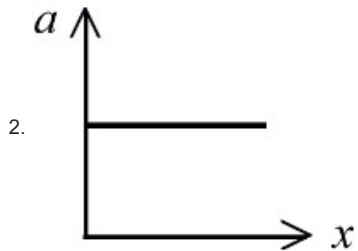
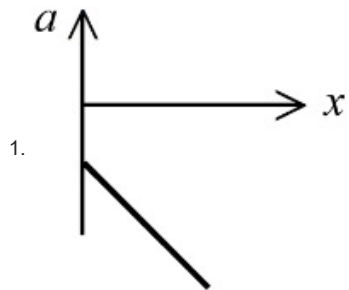

Question Type : **MCQ**

Question ID : **444792628**

Option 1 ID : **4447922134**

Option 2 ID : **4447922137**

Option 3 ID : **4447922135**

Option 4 ID : **4447922136**

Status : **Not Attempted and
Marked For Review**

Chosen Option : --

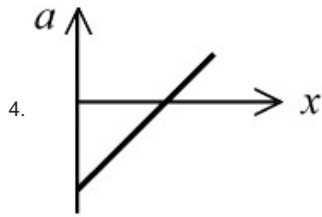

Section : Physics Section B

Q.46 When 300 J of heat given to an ideal gas with $C_p = \frac{7}{2}R$ its temperature raises from 20 °C to 50 °C keeping its volume constant. The mass of the gas is (approximately) _____ g. ($R = 8.314 \text{ J/mol.K}$)

Given Answer --
:

Question Type : SA
Question ID : 444792647
Status : Not Attempted and Marked For Review

Q.47 In a meter bridge experiment to determine the value of unknown resistance, first the resistances 2Ω and 3Ω are connected in the left and right gaps of the bridge and the null point is obtained at a distance l cm from the left. Now when an unknown resistance $x \Omega$ is connected in parallel to 3Ω resistance, the null point is shifted by 10 cm to the right of wire. The value of unknown resistance x is _____ Ω .

Given Answer 6
:

Question Type : SA
Question ID : 444792650
Status : Answered

Q.48 A soap bubble of surface tension 0.04 N/m is blown to a diameter of 7 cm. If $(15000 - x) \mu\text{J}$ of work is done in blowing it further to make its diameter 14 cm, then the value of x is _____. ($\pi = 22/7$)

Given Answer 11304
:

Question Type : SA
Question ID : 444792648
Status : Answered

Q.49 A point charge $q = 1 \mu\text{C}$ is located at a distance 2 cm from one end of a thin insulating wire of length 10 cm having a charge $Q = 24 \mu\text{C}$, distributed uniformly along its length, as shown in figure. Force between q and wire is _____ N.

(Use : $\frac{1}{4\pi\epsilon_0} = 9 \times 10^9 \text{ N.m}^2/\text{C}^2$)

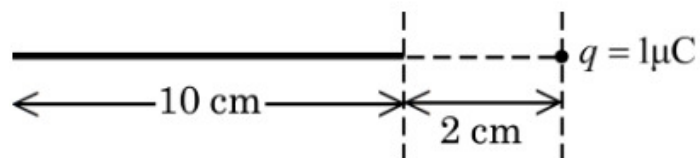

Given Answer 5400

:

Question Type : SA

Question ID : 444792646

Status : Answered

Q.50 A uniform solid cylinder of length L and radius R has moment of inertia about its axis equal to I_1 . A small co-centric cylinder of length $L/2$ and radius $R/3$ carved from this cylinder has moment of inertia about its axis equals to I_2 . The ratio I_1/I_2 is _____.

Given Answer --

:

Question Type : SA

Question ID : 444792649

Status : Not Answered

Q.51

Given below are two statements:

Statement I: The dipole moment of R-CN is greater than R-NC and R-NC can undergo hydrolysis under acidic medium to produce $\text{R} - \overset{\text{O}}{\parallel} \text{C} - \text{OH}$.

Statement II: R-CN hydrolyses under acidic medium to produce a compound which on treatment with SOCl_2 , followed by the addition of NH_3 gives another compound(x). This compound (x) on treatment with NaOCl/NaOH gives a product, that on treatment with $\text{CHCl}_3/\text{KOH}/\Delta$ produces R-NC

In the light of the above statements, choose the *correct* answer from the options given below

- Options
1. Statement I is true but Statement II is false
 2. Both Statement I and Statement II are false
 3. Statement I is false but Statement II is true
 4. Both Statement I and Statement II are true

Question Type : MCQ

Question ID : 444792668

Option 1 ID : 4447922281

Option 2 ID : 4447922280

Option 3 ID : 4447922282

Option 4 ID : 4447922279

Status : Marked For Review

Chosen Option : 3

Q.52 Given below are two statements:

Statement I: Cross aldol condensation between two different aldehydes will always produce four different products.

Statement II: When semicarbazide reacts with a mixture of benzaldehyde and acetophenone under optimum pH, it forms a condensation product with acetophenone only.

In the light of the above statements, choose the *correct* answer from the options given below

- Options
1. Both Statement I and Statement II are false
 2. Both Statement I and Statement II are true
 3. Statement I is false but Statement II is true
 4. Statement I is true but Statement II is false

Question Type : MCQ

Question ID : 444792664

Option 1 ID : 4447922264

Option 2 ID : 4447922263

Option 3 ID : 4447922266

Option 4 ID : 4447922265

Status : Not Answered

Chosen Option : --

Q.53 From the following, how many compounds contain at least one secondary alcohol?

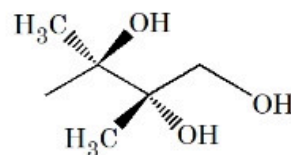
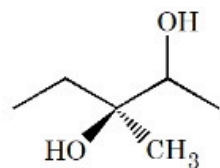
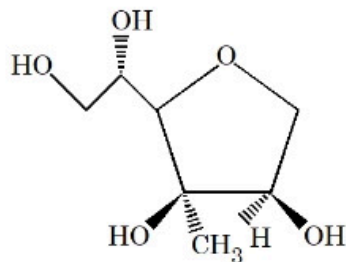
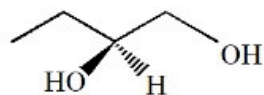
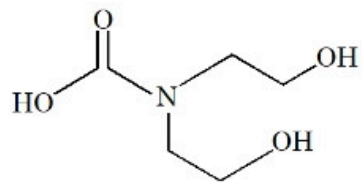

Choose the *correct* answer from the options given below:

- Options
1. Five
 2. Two
 3. Four
 4. Three

Question Type : MCQ

Question ID : 4447922667

Option 1 ID : 4447922276

Option 2 ID : 4447922277

Option 3 ID : 4447922278

Option 4 ID : 4447922275

Status : Answered

Chosen Option : 3

Q.54 Given below are two statements:

Statement I: There are several conformers for n-butane. Out of those conformers,

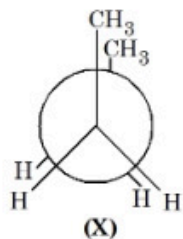

is the least stable and most stable conformer is

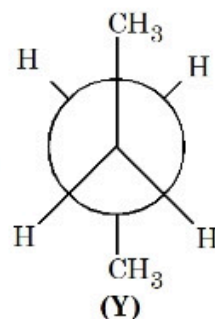

Statement II: As the dihedral angle increases, torsional strain decreases from (X) to (Y).

In the light of the above statements, choose the *correct* answer from the options given below

- Options
1. Statement I is true but Statement II is false
 2. Statement I is false but Statement II is true
 3. Both Statement I and Statement II are true
 4. Both Statement I and Statement II are false

Q.55 At 298 K, the mole percentage of $N_2(g)$ in air is 80%. Water is in equilibrium with air at a pressure of 10 atm. What is the mole fraction of $N_2(g)$ in water at 298 K? (K_H for N_2 is 6.5×10^7 mm Hg)

- Options
1. 9.35×10^5
 2. 9.35×10^{-5}
 3. 1.23×10^{-7}
 4. 1.17×10^{-4}

Question Type : MCQ

Question ID : 444792663

Option 1 ID : 4447922261

Option 2 ID : 4447922262

Option 3 ID : 4447922259

Option 4 ID : 4447922260

Status : Answered

Chosen Option : 3

Question Type : MCQ

Question ID : 444792655

Option 1 ID : 4447922229

Option 2 ID : 4447922227

Option 3 ID : 4447922228

Option 4 ID : 4447922230

Status : Marked For Review

Chosen Option : 2

Q.56 The wavelength of light absorbed for the following complexes are in the order

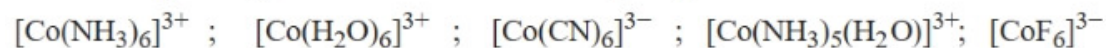

(I)

(II)

(III)

(IV)

(V)

- Options
1. III < IV < I < II < V
 2. III < I < IV < V < II
 3. III < I < IV < II < V
 4. III < I < II < IV < V

Question Type : MCQ

Question ID : 444792661

Option 1 ID : 4447922251

Option 2 ID : 4447922254

Option 3 ID : 4447922253

Option 4 ID : 4447922252

Status : Marked For Review

Chosen Option : 3

Q.57 The number of possible tripeptides formed involving alanine (ala), glycine (gly) and valine (val), where no amino acid has been used more than once is:

- Options
1. 6
 2. 3
 3. 8
 4. 4

Question Type : MCQ

Question ID : 444792669

Option 1 ID : 4447922285

Option 2 ID : 4447922283

Option 3 ID : 4447922286

Option 4 ID : 4447922284

Status : Answered

Chosen Option : 1

Q.58 The unsaturated ether on acidic hydrolysis produces carbonyl compounds as shown below:-

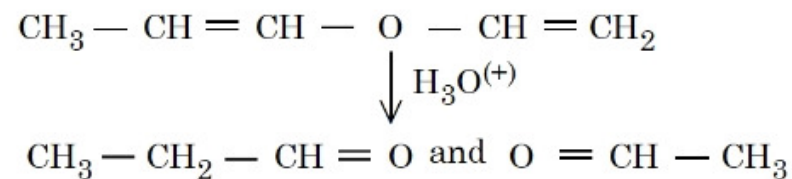

Based on this, predict the solution/reagent that will help to distinguish "P" and "Q" obtained in the following reaction:-

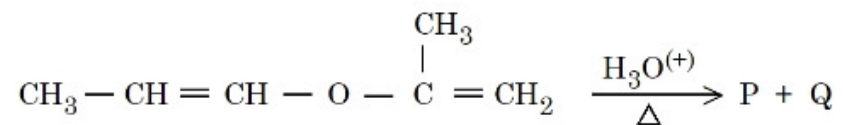

- Options
1. Lucas reagent
 2. Fehling solution
 3. 2, 4 - DNP reagent
 4. Saturated NaHSO₃ solution

Q.59 "X" is an oxoanion of the lightest element of group 7 (in the periodic table). The metal is in +6 oxidation state in "X". The color of the potassium salt of X is

- Options
1. purple
 2. orange
 3. green
 4. yellow

Question Type : MCQ

Question ID : 444792665

Option 1 ID : 4447922270

Option 2 ID : 4447922268

Option 3 ID : 4447922269

Option 4 ID : 4447922267

Status : Marked For Review

Chosen Option : 2

Question Type : MCQ

Question ID : 444792660

Option 1 ID : 4447922248

Option 2 ID : 4447922250

Option 3 ID : 4447922247

Option 4 ID : 4447922249

Status : Not Answered

Chosen Option : --

- Q.60** In the Group analysis of cations, Ba^{2+} & Ca^{2+} are precipitated respectively as
- Options**
1. chromate & sulphide
 2. sulphide & sulphide
 3. hydroxide & carbonate
 4. carbonate & carbonate

Question Type : **MCQ**
Question ID : **444792670**
Option 1 ID : **4447922290**
Option 2 ID : **4447922287**
Option 3 ID : **4447922288**
Option 4 ID : **4447922289**
Status : **Not Answered**
Chosen Option : --

- Q.61** A student has planned to prepare acetanilide from aniline using acetic anhydride.
- The student has started from 9.3 g of aniline. However, the student has managed to obtain 11 g of dry acetanilide.
- The % yield of this reaction is :-
- Options**
1. 59.5%
 2. 81.5%
 3. 72.5%
 4. 97.5%

Question Type : **MCQ**
Question ID : **444792666**
Option 1 ID : **4447922274**
Option 2 ID : **4447922272**
Option 3 ID : **4447922271**
Option 4 ID : **4447922273**
Status : **Answered**
Chosen Option : **2**

- Q.62** The wavelength of spectral line obtained in the spectrum of Li^{2+} ion, when the transition takes place between two levels whose sum is 4 and difference is 2, is
- Options**
1. 2.28×10^{-6} cm
 2. 1.14×10^{-6} cm
 3. 1.14×10^{-7} cm
 4. 2.28×10^{-7} cm

Question Type : **MCQ**
Question ID : **444792652**
Option 1 ID : **4447922215**
Option 2 ID : **4447922216**
Option 3 ID : **4447922217**
Option 4 ID : **4447922218**
Status : **Not Attempted and Marked For Review**
Chosen Option : --

Q.63 Consider the following gaseous equilibrium in a closed container of volume 'V' at T(K).

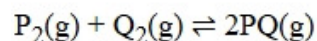

2 moles each of $P_2(g)$, $Q_2(g)$ and $PQ(g)$ are present at equilibrium. Now one mole each of ' P_2 ' and ' Q_2 ' are added to the equilibrium keeping the temperature at T(K).

The number of moles of P_2 , Q_2 and PQ at the new equilibrium, respectively, are

- Options
1. 2.67, 2.67, 2.67
 2. 1.21, 2.24, 1.56
 3. 1.66, 1.66, 1.66
 4. 2.56, 1.62, 2.24

Question Type : **MCQ**

Question ID : **444792657**

Option 1 ID : **4447922236**

Option 2 ID : **4447922237**

Option 3 ID : **4447922235**

Option 4 ID : **4447922238**

Status : **Not Attempted and Marked For Review**

Chosen Option : --

Q.64 Pair of species among the following having same bond order as well as paramagnetic character will be-

- Options
1. O_2^- , N_2^-
 2. O_2^- , N_2^+
 3. O_2^+ , N_2^{2-}
 4. O_2^+ , N_2^-

Question Type : **MCQ**

Question ID : **444792653**

Option 1 ID : **4447922220**

Option 2 ID : **4447922219**

Option 3 ID : **4447922221**

Option 4 ID : **4447922222**

Status : **Marked For Review**

Chosen Option : **4**

Q.65 Two liquids A and B form an ideal solution at temperature T K. At T K, the vapour pressures of pure A and B are 55 and 15 kN m⁻² respectively. What is the mole fraction of A in solution of A and B in equilibrium with a vapour in which the mole fraction of A is 0.8?

- Options
1. 0.5217
 2. 0.663
 3. 0.480
 4. 0.340

Question Type : **MCQ**

Question ID : **444792656**

Option 1 ID : **4447922233**

Option 2 ID : **4447922232**

Option 3 ID : **4447922231**

Option 4 ID : **4447922234**

Status : **Marked For Review**

Chosen Option : **1**

Q.66 The correct order of C, N, O and F in terms of second ionisation potential is

- Options
1. $F < N < C < O$
 2. $C < F < N < O$
 3. $C < O < N < F$
 4. $C < N < F < O$

Question Type : MCQ

Question ID : 444792658

Option 1 ID : 4447922239

Option 2 ID : 4447922241

Option 3 ID : 4447922240

Option 4 ID : 4447922242

Status : Marked For Review

Chosen Option : 2

Q.67

Find out the statements which are **not** true.

- A. Resonating structures with more number of covalent bonds and lesser charge separation are more stable.
- B. In electromeric effect, an unsaturated system shows +E effect with nucleophile and -E effect with electrophile.
- C. Inductive effect is responsible for high melting point, boiling point and dipole moment of polar compounds.
- D. The greater the number of alkyl groups attached to the doubly bonded carbon atoms, higher is the heat of hydrogenation.
- E. Stability of carbanion increases with the increase in s - character of the carbon carrying the negative charge.

Choose the *correct* answer from the options given below:

- Options
1. B & D only
 2. A, D & E only
 3. A, C & D only
 4. B, D & E only

Question Type : MCQ

Question ID : 444792662

Option 1 ID : 4447922255

Option 2 ID : 4447922258

Option 3 ID : 4447922256

Option 4 ID : 4447922257

Status : Marked For Review

Chosen Option : 1

Q.68 Choose the **INCORRECT** statement

- Options
1. Carbon cannot exceed its covalency more than four.
 2. Among the isotopes of carbon, ^{13}C is a radioactive isotope.
 3. Carbon exhibits negative oxidation states along with +4 and +2.
 4. CO_2 is the most acidic oxide among the dioxides of group of 14 elements.

Question Type : MCQ
Question ID : 444792659
Option 1 ID : 4447922243
Option 2 ID : 4447922245
Option 3 ID : 4447922244
Option 4 ID : 4447922246
Status : Answered
Chosen Option : 4

Q.69 The heat of atomisation of methane and ethane are 'x' kJ mol^{-1} and 'y' kJ mol^{-1} respectively. The longest wavelength (λ) of light capable of breaking the C-C bond can be expressed in SI unit as:

- Options
1. $\frac{N_A hc}{250(4y - 6x)}$
 2. $\frac{hc}{1000} \left(\frac{y - 6x}{4} \right)^{-1}$
 3. $N_A hc \left(y - \frac{6x}{4} \right)^{-1}$
 4. $\frac{N_A hc}{250(y - 6x)}$

Question Type : MCQ
Question ID : 444792654
Option 1 ID : 4447922223
Option 2 ID : 4447922224
Option 3 ID : 4447922226
Option 4 ID : 4447922225
Status : Marked For Review
Chosen Option : 1

Q.70 One mole of $\text{Cl}_2(\text{g})$ was passed into 2 L of cold 2M KOH solution. After the reaction, the concentrations of Cl^- , ClO^- and OH^- are respectively (assume volume remains constant)

- Options
1. 0.5M, 0.5M, 0.5M
 2. 0.75M, 0.75M, 1M
 3. 1M, 1M, 1M
 4. 0.5M, 0.5M, 1M

Question Type : MCQ
Question ID : 444792651
Option 1 ID : 4447922213
Option 2 ID : 4447922214
Option 3 ID : 4447922211
Option 4 ID : 4447922212
Status : Not Answered
Chosen Option : --

Q.71 Molar conductivity of a weak acid HQ of concentration 0.18 M was found to be $\frac{1}{30}$ of the molar conductivity of another weak acid HZ with concentration of 0.02 M. If $\lambda^\circ_{Q^-}$ happened to be equal with $\lambda^\circ_{Z^-}$, then the difference of the pK_a values of the two weak acids ($pK_a(HQ) - pK_a(HZ)$) is _____. (Nearest integer).
[Given: degree of dissociation (α) $\ll 1$ for both weak acids, λ° : limiting molar conductivity of ions]

Given Answer 2
:

Question Type : SA
Question ID : 444792674
Status : Answered

Q.72 Grignard reagent $RMgBr$ (P) reacts with water and forms a gas (Q). One gram of Q occupies 1.4 dm^3 at STP. (P) on reaction with dry ice in dry ether followed by H_3O^+ forms a compound (Z). 0.1 mole of (Z) will weigh _____ g. (Nearest integer)

Given Answer 8
:

Question Type : SA
Question ID : 444792672
Status : Marked For Review

Q.73 The half-life of ^{65}Zn is 245 days. After x days, 75% of original activity remained. The value of x in days is _____. (Nearest integer)
(Given: $\log 3 = 0.4771$ and $\log 2 = 0.3010$)

Given Answer 101
:

Question Type : SA
Question ID : 444792675
Status : Answered

Q.74 A chromium complex with a formula $\text{CrCl}_3 \cdot 6\text{H}_2\text{O}$ has a spin only magnetic moment value of 3.87 BM and its solution conductivity corresponds to 1 : 2 electrolyte. 2.75 g of the complex solution was initially passed through a cation exchanger. The solution obtained after the process was reacted with excess of AgNO_3 . The amount of AgCl formed in the above process is _____ g. (Nearest integer)
[Given: Molar mass in g mol^{-1} Cr : 52; Cl : 35.5, Ag:108, O:16, H:1]

Given Answer --
:

Question Type : SA
Question ID : 444792671
Status : Not Attempted and Marked For Review

Q.75 0.25 g of an organic compound "A" containing carbon, hydrogen and oxygen was analysed using the combustion method. There was an increase in mass of CaCl_2 tube and potash tube at the end of the experiment. The amount was found to be 0.15 g and 0.1837 g, respectively. The percentage of oxygen in compound A is ____ %. (Nearest integer)

(Given: molar mass in g mol^{-1} H : 1, C : 12, O : 16)

Given Answer --
:

Question Type : **SA**

Question ID : **444792673**

Status : **Not Answered**